

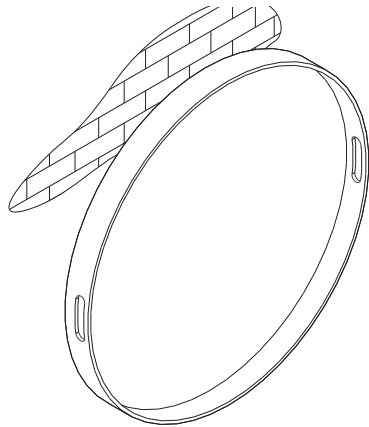

Ethnicraft

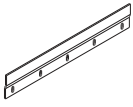

ASSEMBLY INSTRUCTION FOR TRAY INSTALLATION

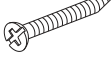
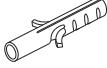

HARDWARE ENCLOSED

 METAL HANGER 2 pcs	 WOOD SCREW 4 pcs
 SCREW 3 pcs (not included in package)	 WALL PLUG 3 pcs (not included in package)

TOOLS

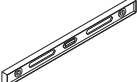
 PHILLIPS SCREWDRIVER (not included in package)	 PENCIL (not included in package)
 DRILL (not included in package)	 LEVEL (not included in package)



AS WALL MATERIALS VARY, SCREWS FOR FIXING TO WALL ARE NOT INCLUDED. FOR ADVICE ON SUITABLE SCREW SYSTEMS, CONTACT YOUR LOCAL SPECIALISED DEALER.

NOTICE

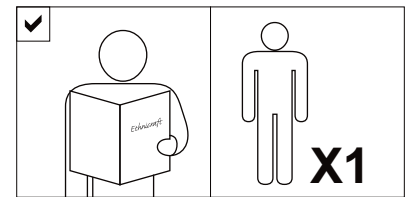

SYMBOLS



DIRECTION



NUMBER OF PERSON NEEDED



USE HAND

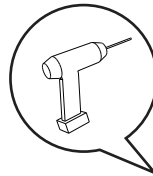

USE DRILL

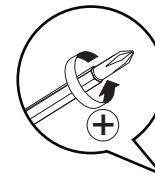

USE PHILLIPS SCREWDRIVER TO TIGHTEN

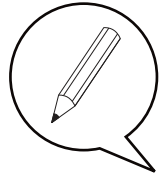

USE PENCIL

INSTALLING METAL HANGER ON THE TRAY

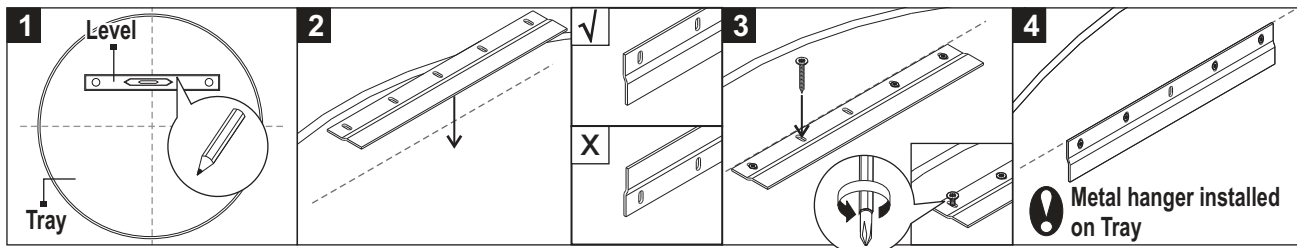

HANGING ITEM WITH THE METAL HANGER

